

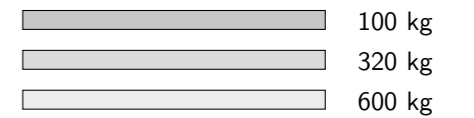

Description		Scale
Working area (theoretical) RUTHMANNSTEIGER® T 510 flex-3A Scania P460 B 6x4 NZ CP20L		1:600
		Com. No. 34216
Ruthmann Holdings GmbH Ruthmannstr. 4 48712 Gescher Germany		Sheet 1
		No. Sheets 2
Working height max.  50,9 m	Outreach max.  32,4 m	
Date: 26th July 2023	Format: A3	FTA-gb

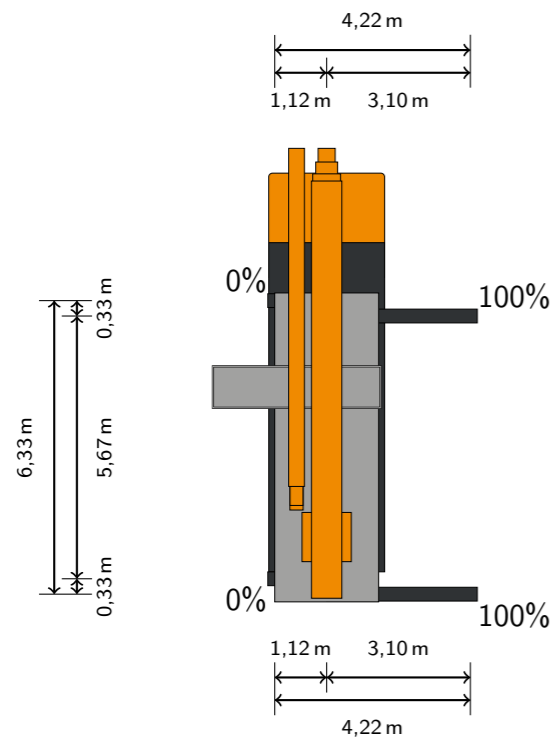
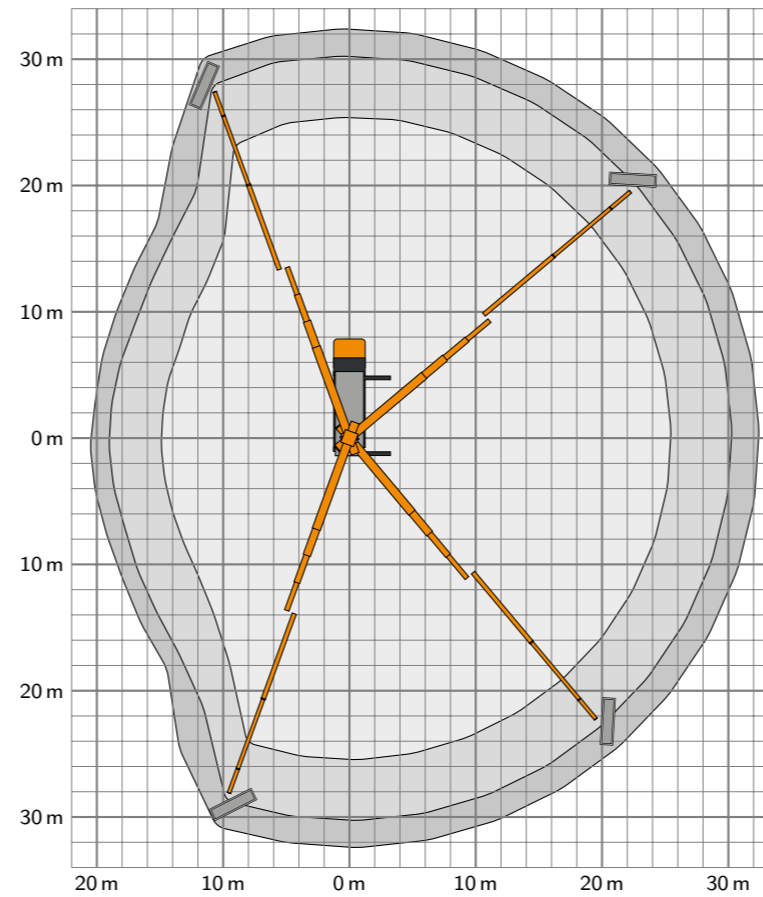
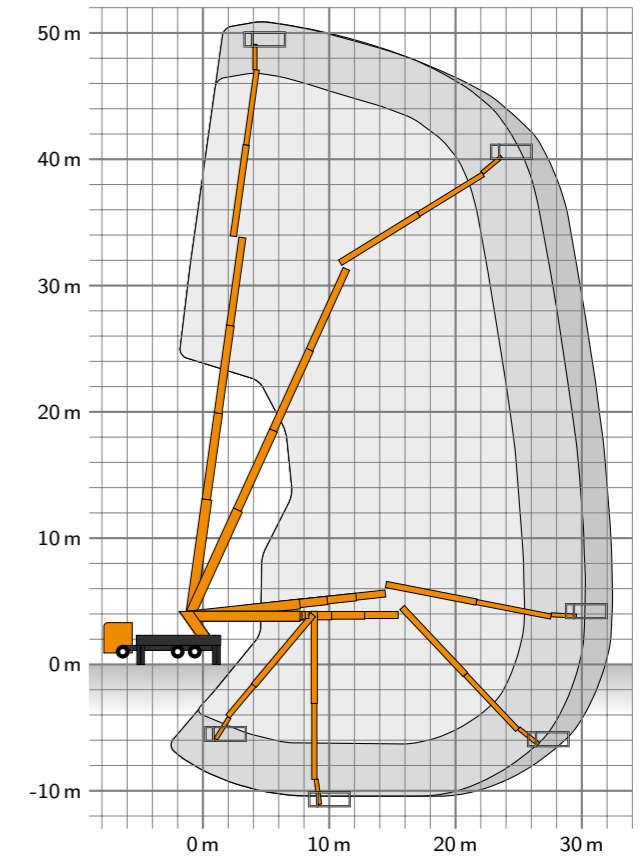
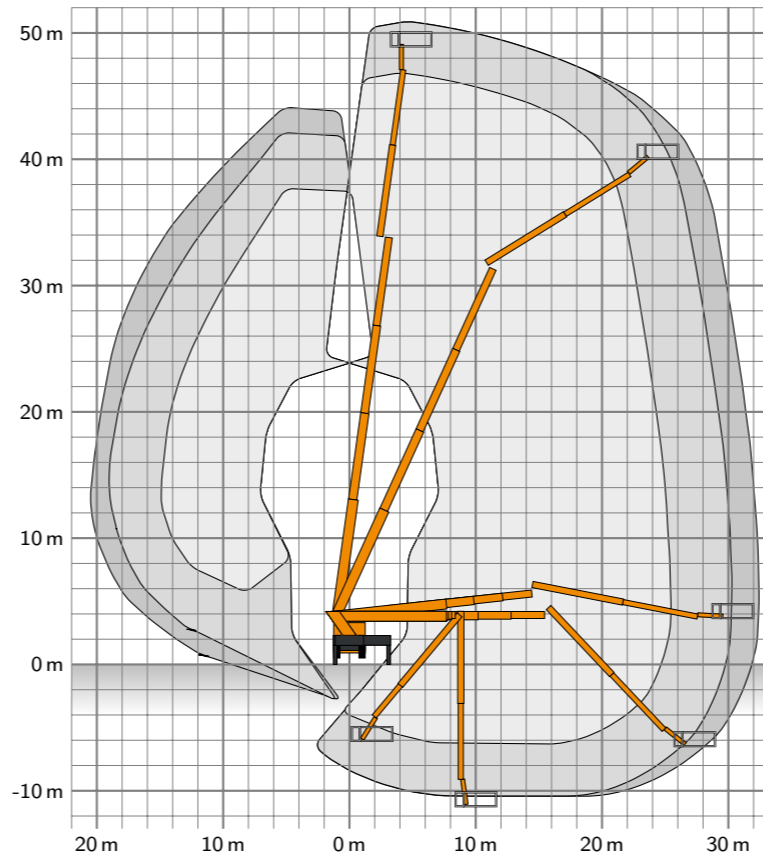
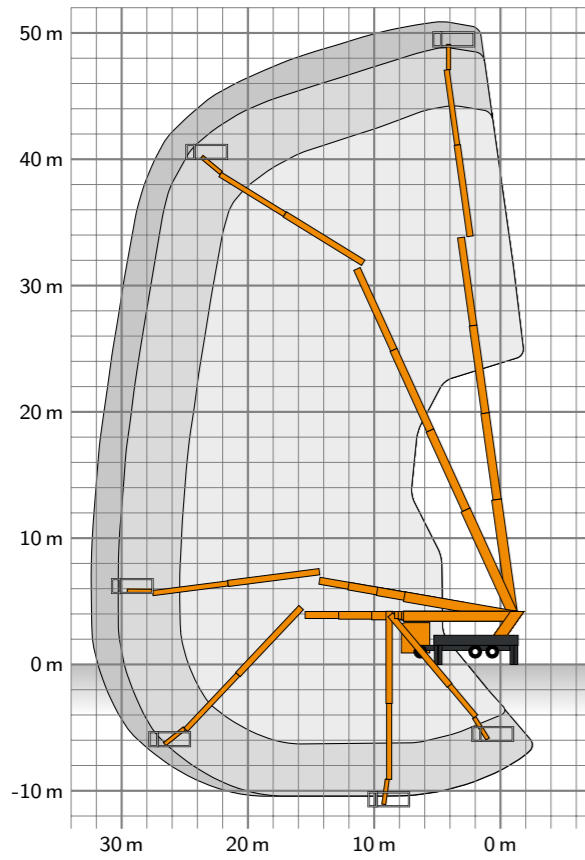

Description		Scale
Working area (theoretical) RUTHMANNSTEIGER® T 510 flex-3A Scania P460 B 6x4 NZ CP20L		1:600
		Com. No. 34216
Ruthmann Holdings GmbH Ruthmannstr. 4 48712 Gescher Germany		Sheet 2
		No. Sheets 2
Working height max. 50,9 m	Outreach max. 32,5 m	
Date: 26th July 2023	Format: A3	FTA-gb